

Article number: 090610828

Description: KLEE Feather keys B 10x8x28 DIN 6885

Measures

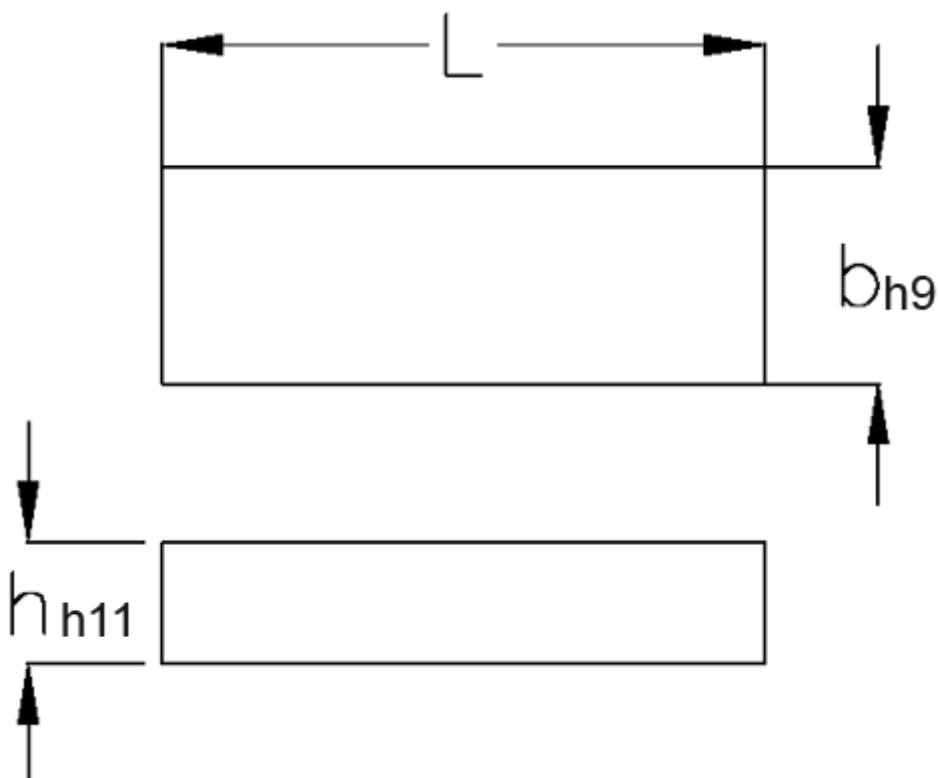

b = 10

h = 8

L = 28

Tolerance b = 0.036

Tolerance h = 0.090

Tolerance L = -0,3